

# Europa SP



## Porta scorrevole a due ante.

Apertura laterale ad anta scorrevole, una fissa ed una apribile. Profili superiori e verticali portanti, assenza di quelli inferiori. Chiusura rallentata delle ante con sistema Soft Closing.

## Porte de douche coulissante à deux panneaux.

Ouverture latérale par un panneau coulissant sur un panneau fixe. Fermeture amortie des panneaux avec système "soft-closing".

## Two panels door.

Lateral opening with sliding panel (one fixed and one can be opened). Slow-closing doors with "soft-closing" system.

## Frontal corredera con dos paneles,

apertura lateral con hoja fija y una corredera. La estructura está formada de perfiles verticales y superiores, ausencia de perfiles inferiores. Puertas de cierre lento con sistema de "cierre suave".

## 2-tlg. Schiebetür

mit einer festen und einer Schiebetür. Verlangsamte Schließung der Türen mit "soft-closing" System.

## Glijdeur met twee panelen,

Lateraal openschuivende douchewand met één vast en één openschuivend paneel. Langzaam openen deuren met "soft closing" systeem.

## Двустворчатая раздвижная дверь,

боковое открытие с раздвижной створкой, одна стационарная и другая открывающаяся. Несущие верхний и вертикальные профили, нижние отсутствуют. Медленное открытие дверей с "soft-closing" закрытия системы.

5 anni di garanzia\_Garantie 5 an\_5 Years Warranty\_Garantia De 5 Años\_5 Jahre Garantie\_5 Jaar Garantie\_ЛЕТ ГАРАНТИЯ

5



H 196,5 cm. - V 6 mm.

## Finitura profili

Finitions des profilés\_Profiles finishing \_Acabado perfiles  
Profilfarbe\_Profil afwerkingen \_Отделка профилей

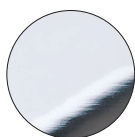

**ULU  
brillantato cromo**  
chromé brillant  
brilliant chrome  
aluminio cromo  
Chrom glänzend  
glanzend chrom  
светлый блестящий хром

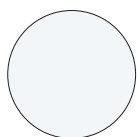

**L01  
bianco**  
blanc  
white  
blanco  
Weiß  
wit  
белый

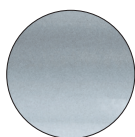

**SAR  
satinato argento**  
satiné argent  
silver glazed satin  
satinado plata  
Satinierter silber  
satijn zilver  
сатинованное  
серебро

## Finitura pannelli

Finitions des panneaux\_Panels finishing \_Acabado perfiles  
Glasart\_Paneel afwerkingen \_Отделка панелей



**TR  
trasparente**  
transparent  
transparent  
transparente  
Klarglas  
transparent  
прозрачное



**ST  
Stampato**  
granité  
frosté  
estampado  
Bedrucktes Glas  
gemarteld  
узорчатое

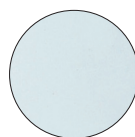

**AS  
Satinato Acqua**  
satiné Acqua  
satin Acqua  
satinado Acqua  
Satiniertes Glas Acqua  
satijn Acqua  
сатинованное Acqua

## Porta scorrevole a due ante

Porte de douche coulissante à deux panneaux

Two panels door

Frontal con una puerta corredera

2-tlg. Schiebetür

Glijdeur met twee panelen

Раздвижная двустворчатая дверь



Trattamento anticalcare di serie compreso nel prezzo

Traitement anti-calcaire inclus dans le prix

Anti-limescale treatment included in the price

Tratamiento antical incluido en el precio

Gegen Kalkablagerungen schützende Glasbehandlung im Preis begriffen

Anti-kalkafwerking inbegrepen in de prijs

Средство от известкового налета включено в цену

Z [cm]	Cod.	A [cm]	B [cm]	C [cm]	[dm <sup>3</sup> ]	[kg]	[n°]
96-101	B7980	45,7-48	46,9	36	121	37	1
103-108	B7981	49-51,5	50,4	40	130	39	1
110-115	B7982	52,5-55	53,9	43	137	40	1
116-121	B7983	55,7-58	56,9	46	145	42	1
123-128	B7984	59-61,5	60,4	50	156	44	1
130-135	B7985	62,5-65	63,9	53	158	46	1
136-141	B7986	65,5-68	66,9	56	260	51	2
145-150	B7987	70-72,5	71,4	61	265	52	2
152-157	B7988	73,7-76	74,9	64	273	54	2
159-164	B7989	77-79,5	78,4	68	286	57	2
166-171	B7990	80,5-83	81,9	71	294	60	2
173-178	B7991	84-86,5	85,4	75	302	63	2

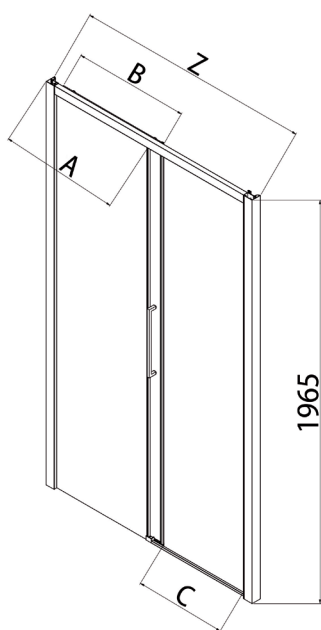

**320 mm**

Interasse maniglia  
Empattement de la poignée  
Handle wheelbase  
Distancia entre ejes de la manija  
Radstand handhaben  
Handvat wielbasis  
Колесная база ручки

**samo**

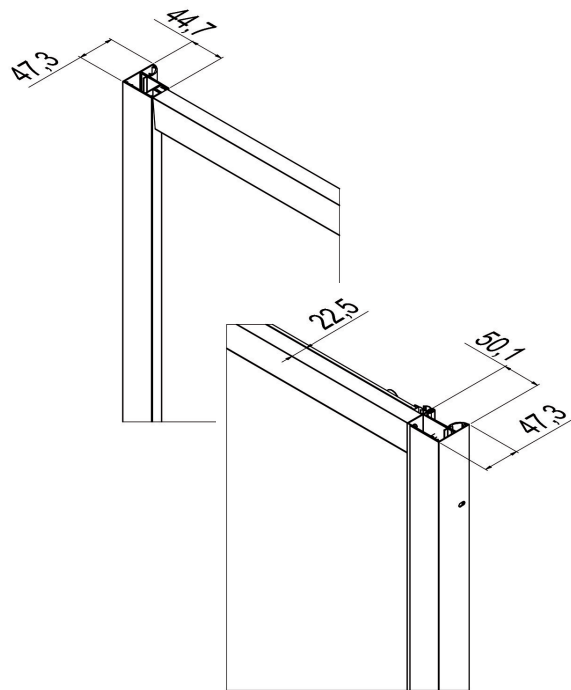
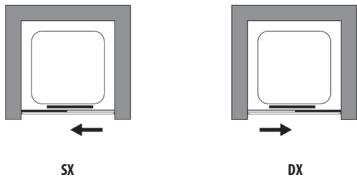
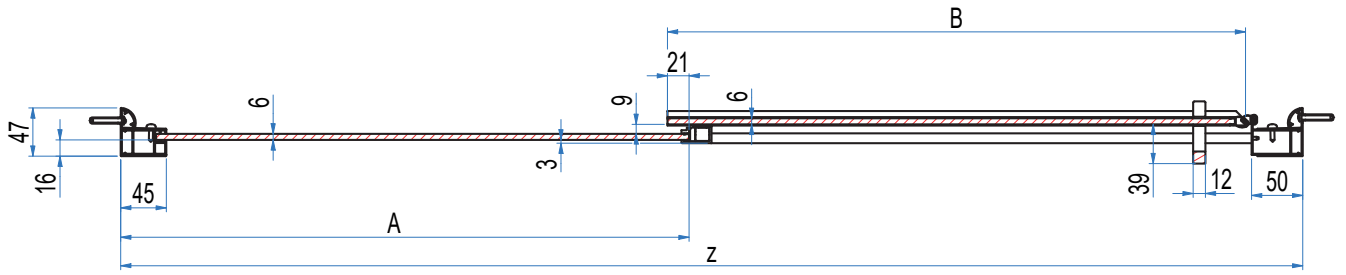





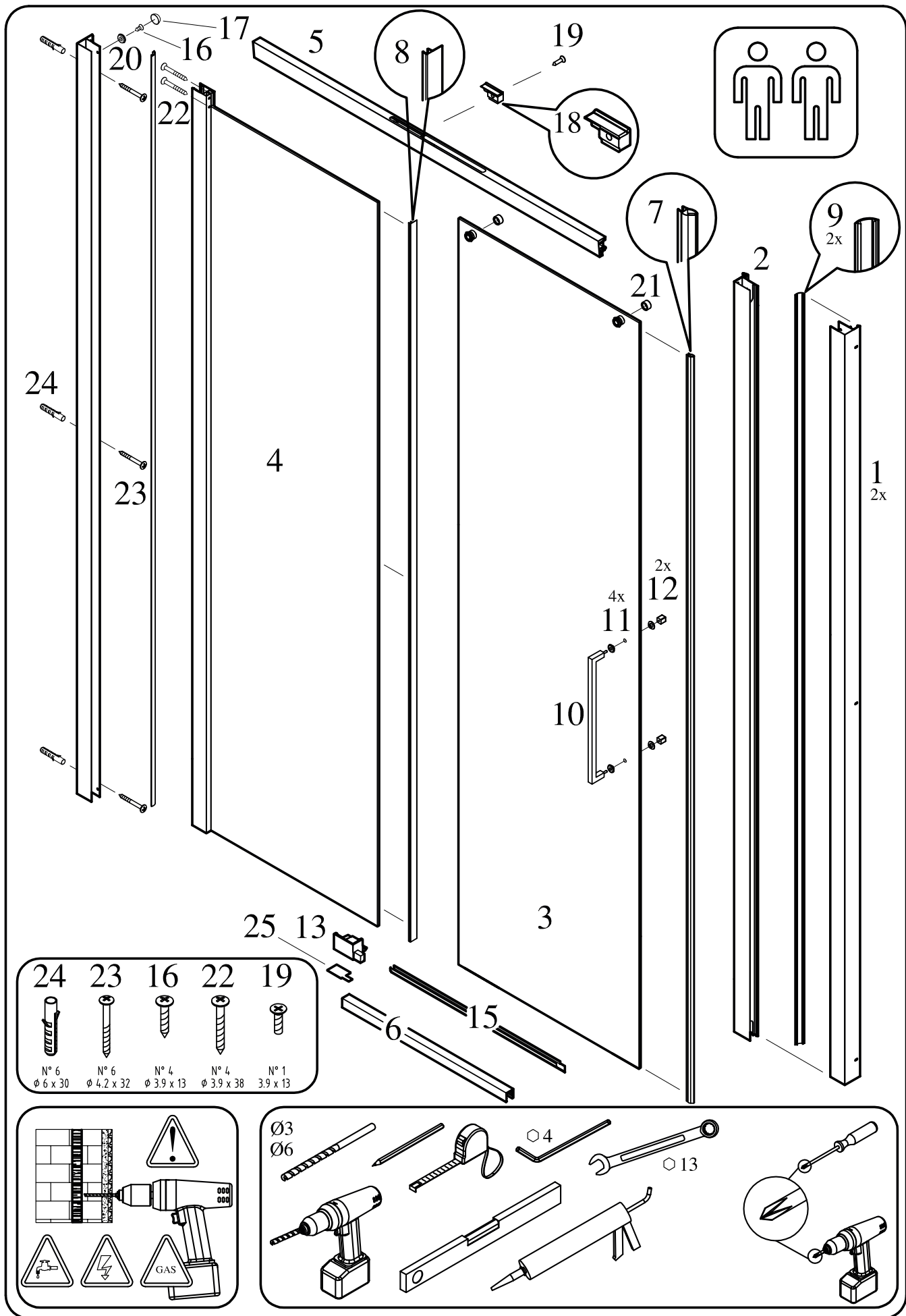

Prodotti Speciali - Produits Spéciaux - Special products - Productos Especiales - Sonderfertigungen - Maatwerk - Специальные Иродукты

MISURE LIMITE	Altezza max 200 cm.	Larghezza max 180 cm.	Larghezza min 80 cm.	
MESURES LIMITES	Hauteur max 200 cm.	Largeur max 180 cm.	Largeur min 80 cm.	
LIMITS OF MEASUREMENTS	Height max 200 cm.	Width max 180 cm.	Width min 80 cm.	
MEDIDAS LIMITE	Altura max 200 cm.	Anchura max 180 cm.	Anchura min 80 cm.	
GRENZMAßE	Höhe max 200 cm.	Breite max 180 cm.	Breite min 80 cm.	
EXTREME MATEN	Hoogte max 200 cm.	Breedte max 180 cm.	Breedte min 80 cm.	
ПРЕДЕЛЬНЫЕ РАЗМЕРЫ:	Макс. высота 200 см	Макс. ширина 180 см	Мин. ширина 80 см	

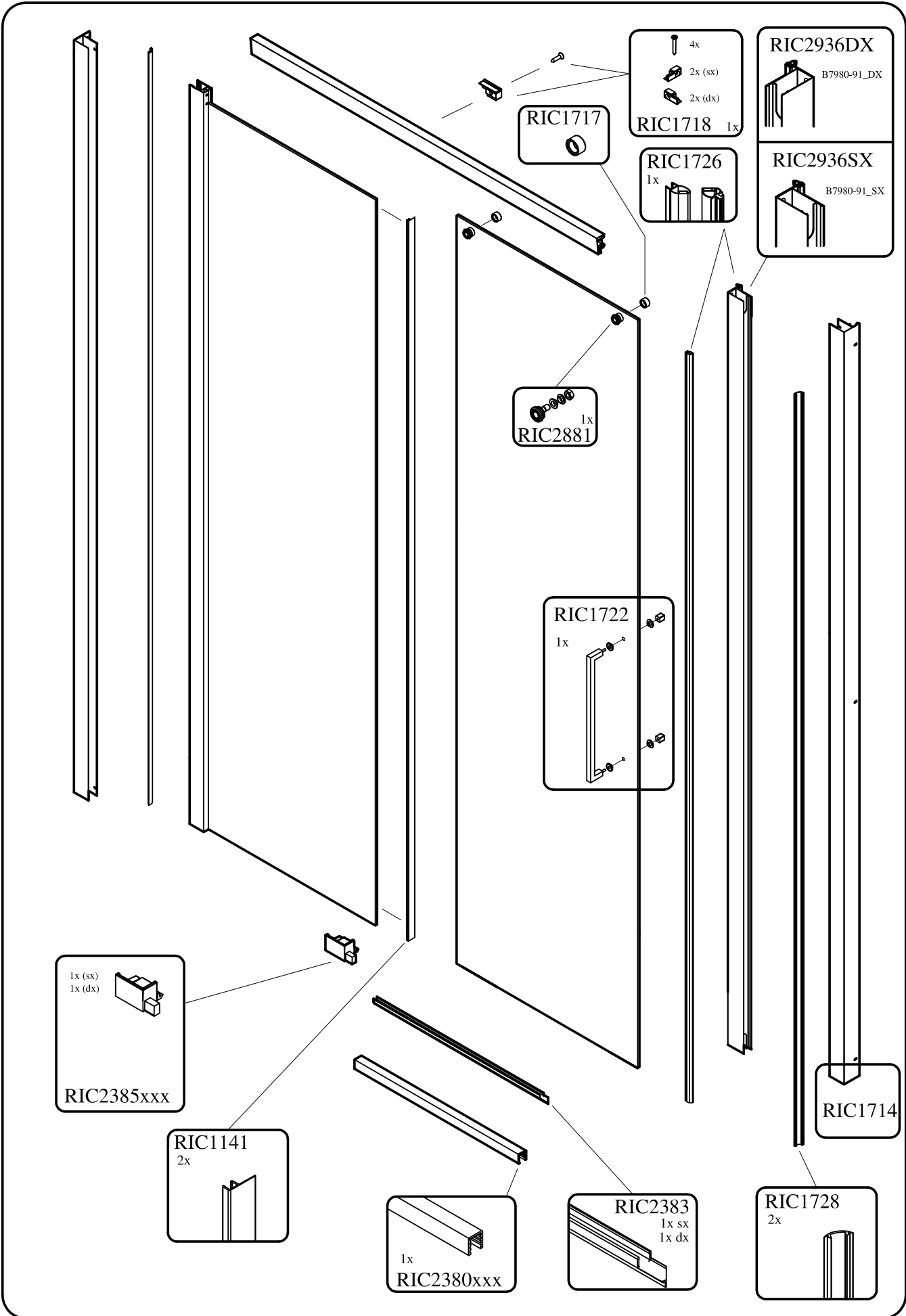
	I								
	II								
	III								

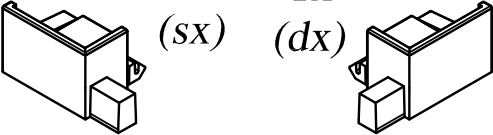
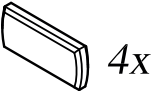
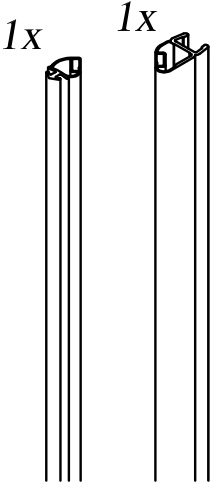
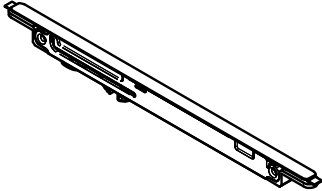
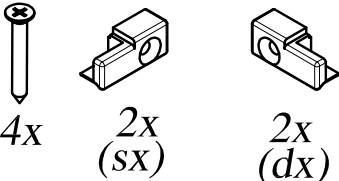
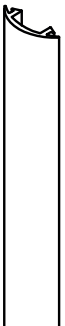
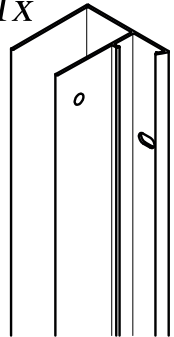

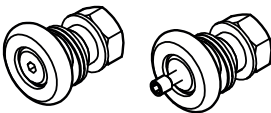
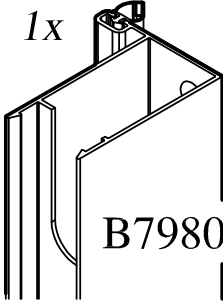
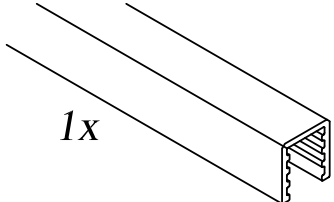

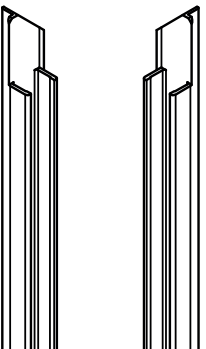
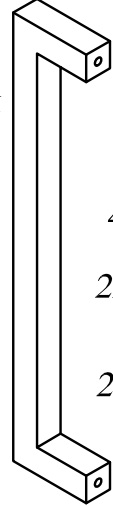
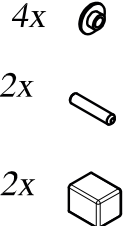
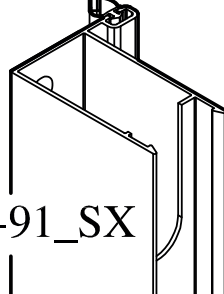
<p><b>RIC2385xxx</b></p> <p>1x (sx)    1x (dx)</p> 		<p><b>RIC2880</b></p> <p>4x</p> 	<p><b>RIC1726</b></p> <p>1x    1x</p> 
<p><b>RIC2849</b></p> 		<p><b>RIC1718</b></p> <p>4x    2x (sx)    2x (dx)</p> 	
<p><b>RIC1728</b></p> <p>2x</p> 	<p><b>RIC1714</b></p> <p>1x</p> 	<p><b>RIC1717</b></p> <p>4x</p> 	
<p><b>RIC2881</b></p> <p>2x    2x</p> 		<p><b>RIC2936DX</b></p> <p>1x</p>  <p>B7980-91_DX</p>	<p><b>RIC2380xxx</b></p> <p>1x</p> 
<p><b>RIC1141</b></p> <p>2x</p> 		<p><b>RIC2383</b></p> <p>1x (sx)    1x (dx)</p> 	<p><b>RIC1722</b></p> <p>1x</p>  <p>4x @</p> <p>2x</p> <p>2x</p> 
<p><b>RIC2936SX</b></p> <p>1x</p>  <p>B7980-91_SX</p>		<p><b>RIC2728</b></p> <p>6x    6x</p> <p>10x    4x</p> 