



**Parete fissa per abbinamenti,**  
è possibile formare cabine doccia a due o tre lati, anche misure rettangolari.

**Paroi fixe pour réaliser des combinaisons**  
pour former des parois à deux ou trois côtés, également pour des dimensions rectangulaires. Non installable seule ou comme paroi de division.

**Fixed panel for combinations**  
to form 2 or 3 sides shower enclosures, also in rectangular sizes. Not to be installed on its own or as dividing screen.

**Panel fijo,**  
combinaciones posibles para la formación de cabinas de ducha de dos o tres lados, también en medidas rectangulares. No instalable para ir sola o como panel divisorio.

**Festwand für Kombinationen**  
zur Gestaltung von Duschkabinen mit 2 oder 3 Seiten, auch regelmäßige Maße. Keine einzelne Installation.

**Vaste wand voor samenstellingen,**  
van twee of driezijdige douchezellen, mogelijkheid tot rechthoekige maten. Niet alleen of als schidingwand plaatsbaar.

**Стационарная панель для комбинирования**  
с душевыми кабинками. Можно создать душевые кабины с двумя или тремя сторонами, а также с прямоугольными размерами. Не устанавливается одиночно или как перегородки.



**H 195 cm. - V 6 mm.**

## Finitura profili

Finitions des profilés\_Profiles finishing \_Acabado perfiles  
Profilfarbe\_Profiel afwerkingen\_Отделка профилей

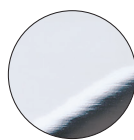

**ULU**  
**brillantato cromo**  
chromé brillant  
brilliant chrome  
aluminio cromo  
Chrom glänzend  
glanzend chroom  
светлый блестящий хром

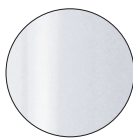

**L01**  
**bianco**  
blanc  
white  
blanco  
Weiß  
wit  
белый

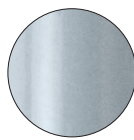

**SAR**  
**satinato argento**  
satiné argent  
silver glazed satin  
satinado plata  
Satinert Silber  
satijn Zilver  
сатинированное серебро

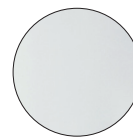

**TR**  
**trasparente**  
transparent  
transparent  
transparente  
Klarglas  
transparent  
прозрачное



**ST**  
**Stampato**  
granité  
frostado  
estampado  
Bedrucktes Glas  
gemarteld  
узорчатое

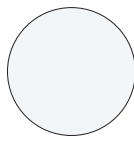

**L91**  
**bianco opaco**  
blanc mat  
matt white  
blanco mate  
Matt Weiß  
wit matte  
белый Матовая

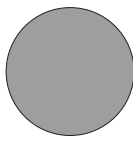

**L95**  
**grigio opaco**  
gris mat  
matt grey  
gris mate  
Matt Grau  
grijs matte  
серый Матовая



**L96**  
**nero opaco**  
noir mat  
matt black  
negro mate  
Matt Schwarz  
zwart matte  
черный Матовая

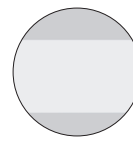

**RF**  
**trasparente con fascia Satinata**  
transparent bande sérigraphiée  
transparent with serigraphy band  
serigrafia franja  
Klarglas siebdruck Band  
transparent zeefdruk band  
прозрачное рисунок шелкография полоса

## Parete fissa per abbinamenti

Paroi fixe pour réaliser des combinaisons



Fixed panel for combinations

Panel fijo para combinaciones

Festwand für Kombinationen

Vaste wand voor samenstellingen

Стационарная панель для комбинирования

Z [cm]	Cod.	A [cm]	B [cm]	C [cm]	 [dm <sup>3</sup> ]	 [kg]	 [n°]
67-69	B0924	//	//	//	116	23	1
70-72	B0925	//	//	//	117	23,5	1
75-77	B0960	//	//	//	118	24	1
77-79	B0926	//	//	//	122	25	1
80-82	B0927	//	//	//	124	26	1
87-89	B0928	//	//	//	130	27	1
90-92	B0961	//	//	//		29	1
97-99	B0929	//	//	//	136	30	1

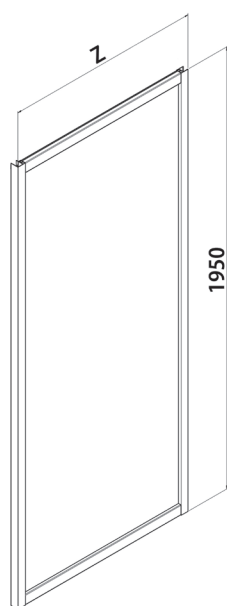

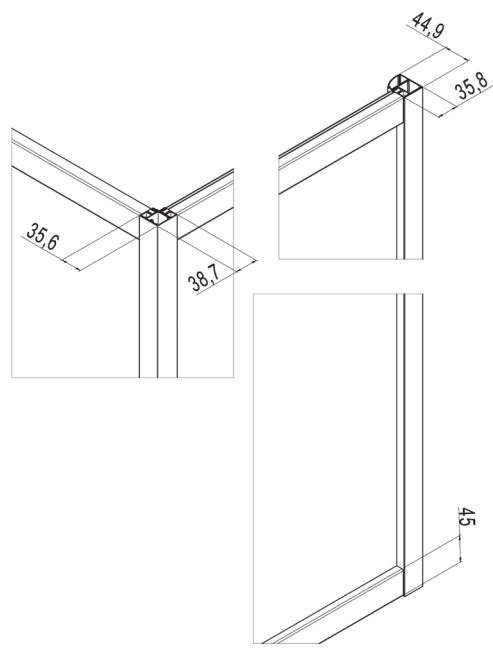
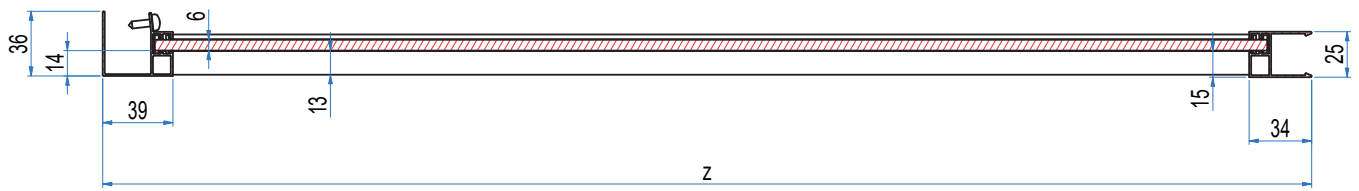

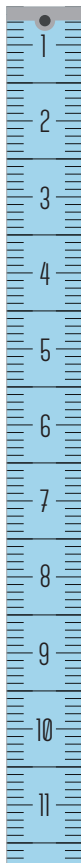

Prodotti Speciali - Produits Spéciaux - Special products - Productos Especiales - Sonderfertigungen - Maatwerk - Специальные Иродукты

MISURE LIMITE	Altezza max 200 cm.	//	Larghezza max 130 cm.	Larghezza min 50 cm.
MESURES LIMITES	Hauteur max 200 cm.	//	Largeur max 130 cm.	Largeur min 50 cm.
LIMITS OF MEASUREMENTS	Height max 200 cm.	//	Width max 130 cm.	Width min 50 cm.
MEDIDAS LIMITE	Altura max 200 cm.	//	Anchura max 130 cm.	Anchura min 50 cm.
GRENZMAßE	Höhe max 200 cm.	//	Breite max 130 cm.	Breite min 50 cm.
EXTREME MATEN	Hoogte max 200 cm.	//	Breedte max 130 cm.	Breedte min 50 cm.
ПРЕДЕЛЬНЫЕ РАЗМЕРЫ:	Макс. высота 200 см	//	Макс. ширина 130 см	Мин. ширина 50 см

	I								
	II								
	III								

B0980-0990  
B0944-0948  
B0901-0904  
B0916-0923  
B0930-0934  
B0907-0911  
B0952-0954

1

2  
2x

3  
2x

2



N°2  
ø 3.9x13

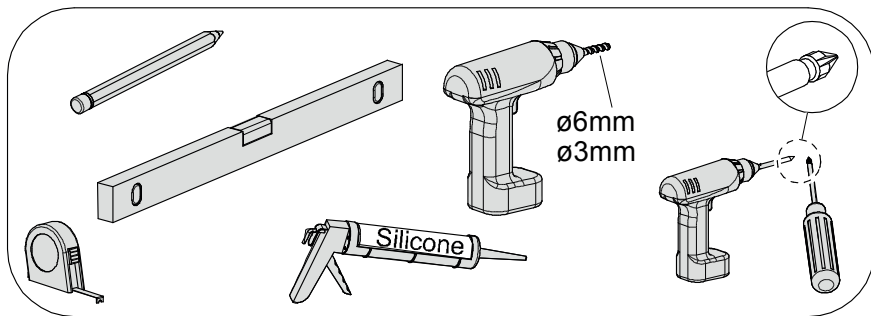
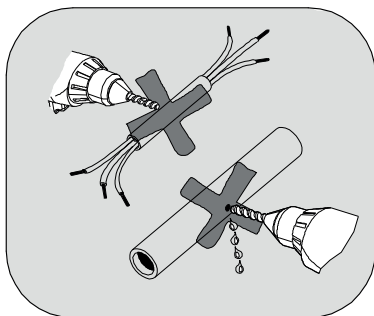

ø6mm  
ø3mm

RIC1799

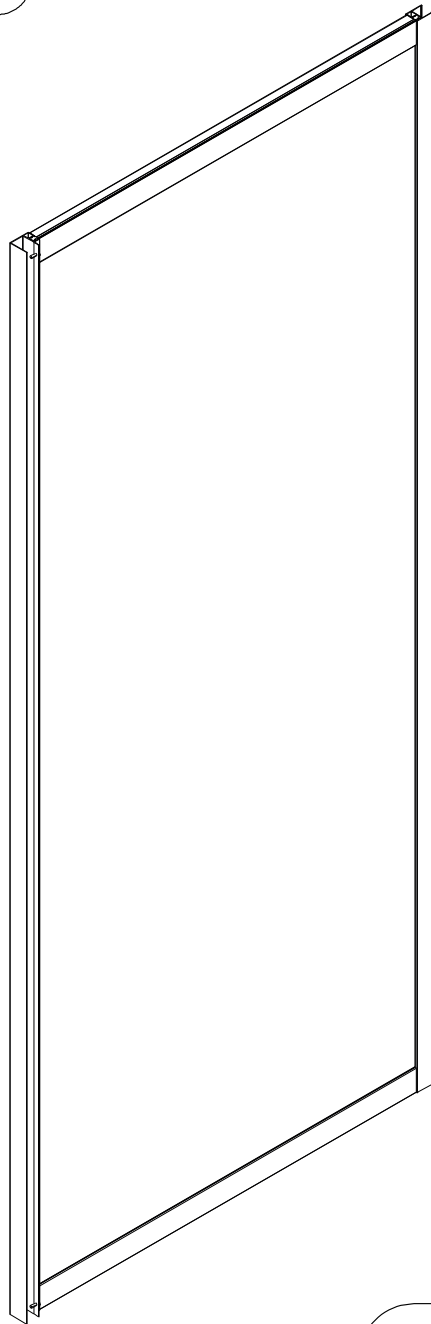

RIC1798  
1x

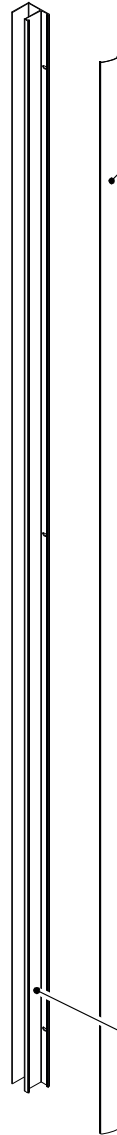

RIC2233  
1x

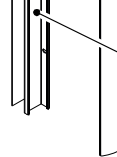

*RIC 1799*

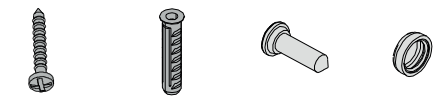

6X

6X

4X

4X

*RIC 1798*

1X



*RIC 2233*

1X

