

**BARRA PIENA Ø14 MM  
ALTERNATA A TUBO CON INSERTO  
TONDINO CARBOCEMENTATO  
ANTITAGLIO**

BARRE COMPLÈTE 14MM ALTERNÉE AVEC TUBE AVEC INSERT  
ROND CARBOCÉMENTÉ' ANTI-COUPURE

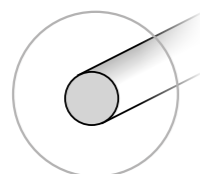

**BARRA PIENA  
14X14 mm  
NELLA VERSIONE  
QUADRATA**

BARRE COMPLÈTE 14X14 MM  
EN VERSION CARRÉE

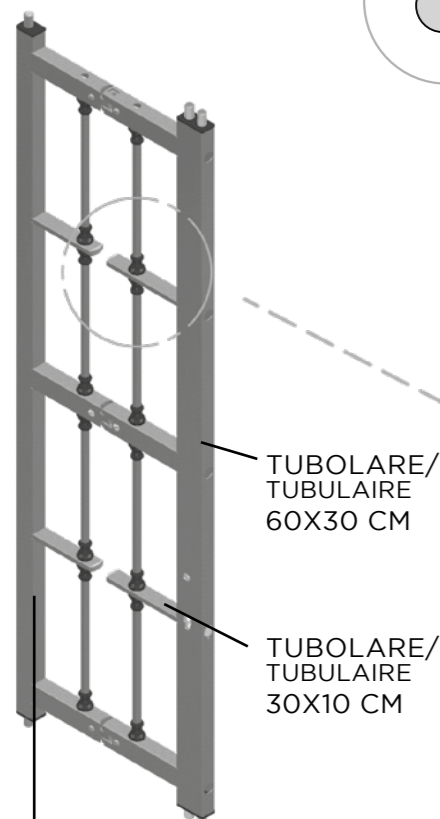
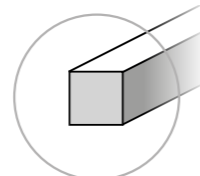

TUBOLARE/  
TUBULAIRE  
60X30 CM

TUBOLARE/  
TUBULAIRE  
30X10 CM

TUBOLARE/  
TUBULAIRE  
40X30 CM

**DEFENDER  
D200**



**FINESTRA  
2 Ante 2 Snodi**

FENÊTRE À 2 VANTAUX  
2 ARTICULATIONS

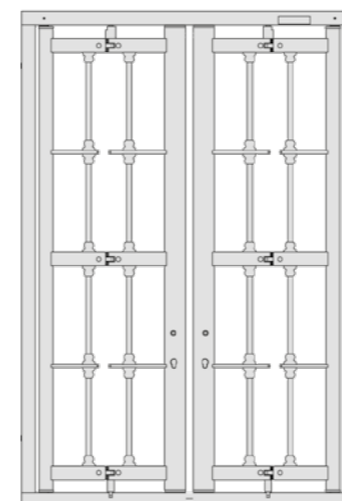

**PORTA FINESTRA  
2 Ante 2 Snodi**

PORTE FENÊTRE À 2 VANTAUX  
2 ARTICULATIONS

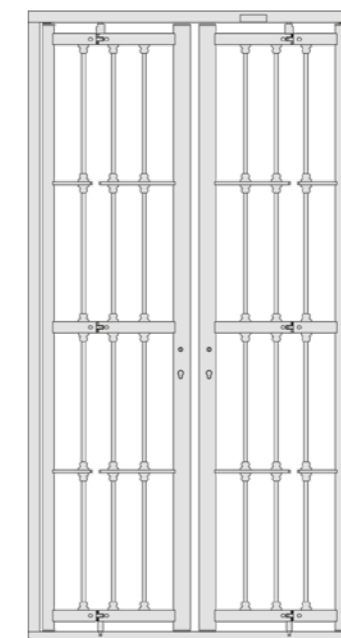

**FISSA  
FIXE**

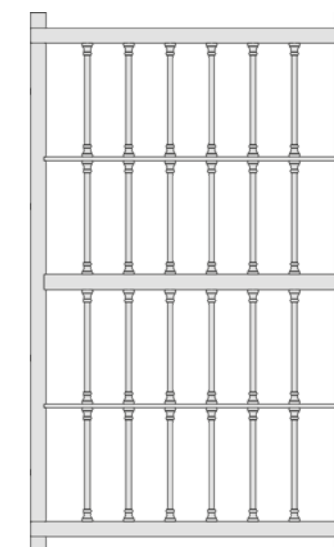

1 ANTA 2 SNODI  
1 VANTAIL 2 ARTICULATIONS

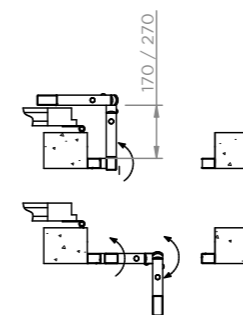

1 ANTA 1 SNODO  
1 VANTAIL 1 ARTICULATION

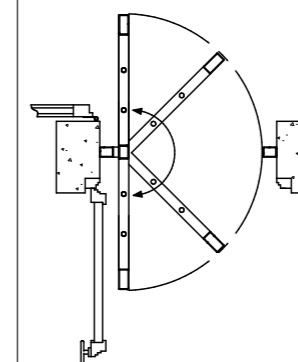

ANTA FISSA  
VANTAIL FIX

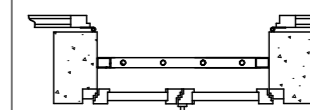

2 ANTE 2 SNODI  
2 VANTAIL 2 ARTICULATIONS

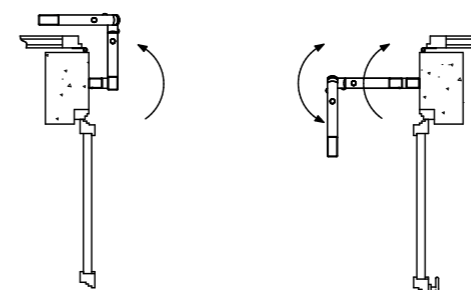

2 ANTE 1 SNODO  
2 VANTAIL 1 ARTICULATIONS

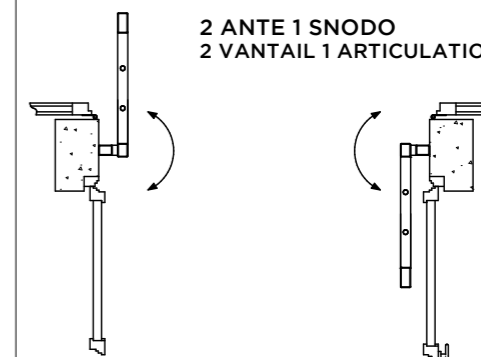

SOLUZIONI TECNICHE

SOLUTIONS TECHNIQUES